

The WISY Filter Collector Type FS Installation Instructions

Remarks

The Filter Collector bodies are manufactured in high grade copper or zinc and the filter element is stainless steel.

The components are manufactured using the latest production techniques and are required to undergo the most rigorous quality control to ensure trouble free operation. In the unlikely occurrence that parts do prove defective, WISY will guarantee replacement.

Note: This guarantee does not cover damage sustained through faulty installation or careless handling.

The exact knowledge and observation of these installation instructions are prerequisites for the operation of WISY Filter Collectors.

Field of Application

The Filter Collectors are designed to be inserted directly into the vertical section of rainwater pipe.

Construction and Mode of Operation

● The WISY Filter Collector filters the roof run-off water directly in the rainwater downpipe and then passes the filtered water through the outlet connection to the storage tank. The special construction of the filter is designed to separate coarse materials like leaves, moss, insects, etc. as well as fine pollutants which are washed through the downpipe to the soakaway or drain.

● With a mesh size of 0.18 mm the unit, without further filtering can supply water suitable for washing machines, WC etc.

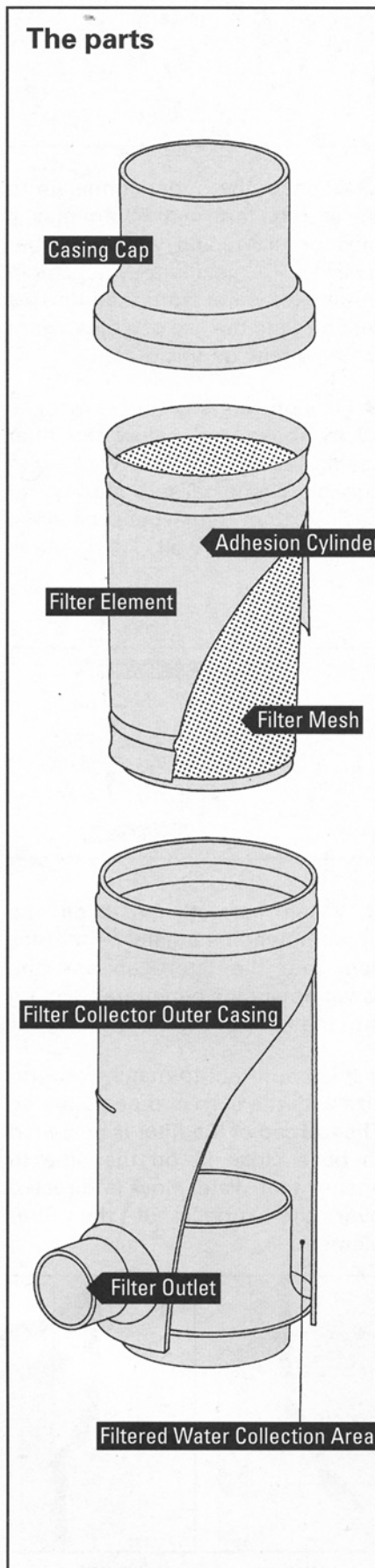

● The construction of the Filter Collector unit creates no obstruction or narrowing of the downpipe. The Gentle Gravity Filtering Technology (Euro patent) ensures that the full flow of the rainwater in the downpipe and through the filter is maintained. This is especially important in the case of cloudbursts. In average rainfall, over 90% of the roofs rainwater can be collected. Even in heavy downpours over 50% of the flow is filtered and collected.

● The filters are available in copper or zinc and the filter element is stainless steel in both cases. With this is the corrosion and frost resistance ensured. The compact type of construction and the small dimensions allow for simple installation to almost any downpipe.

The types of Filter Collector

● The WISY Filter Collector is compatible with European standard. Zinc and copper piping 100 mm, 87 mm and 80 mm sizes are available. A 110 mm version is available for 110 mm plastic pipes (Also 68 mm). In other cases we recommend adjusting the rainwater downpipe to the size of a Filter Collector.

● When new, the finish of the Filter Collectors are generally shiny metal. After some time the zinc oxidises to a dull grey protective layer whilst copper becomes a dark brown colour.

Please note:

The most ideal collecting surfaces are pitched roofs of tile or slate. Turf roofs are less suitable due to their low water yield. Asbestos or heavily soiled roofs should not be used.

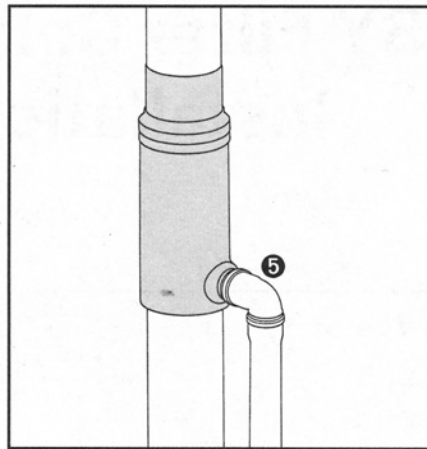
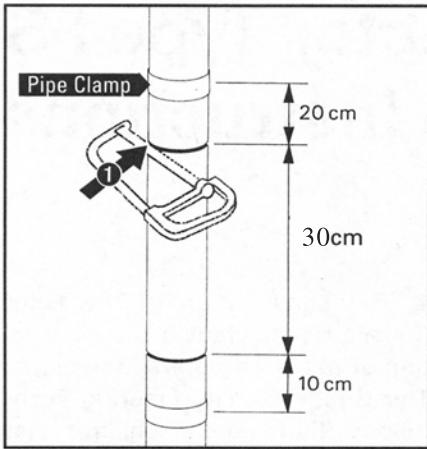

Maintenance

● The maintenance required is minimal. The filter mesh to a large extent is self cleansing, and with very little debris remaining on the vertical stationary filter element.

However over a period of time, depending on the roofing material and locality, a thin coating forms on the filter element.

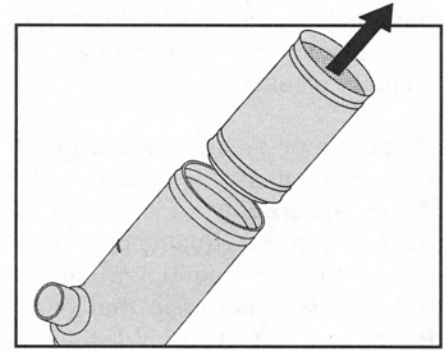

Installation*

① Remove a 30 cm section of the rainwater downpipe at the desired installation height. Clean up the saw cut ends of the pipe with a half-round file.

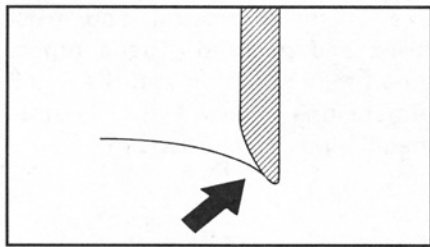

Important: the inner edge of the upper cut must be well rounded

⑤ Connect the outlet connectin to the storage tank with 50mm plastic pipe or steel pipe with a rubber gasket. To facilitate the rapid outflow of water from the filter, we recommend the use of a downward facing elbow on this outlet.

● Fix both ends of the downpipe 20cm above and below the filter casing back to the wall with suitable clamps. There should not be less than 2cm space between the pipe and the wall.

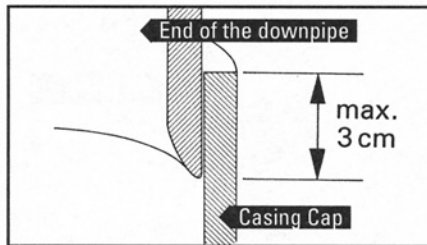

● This has little effect on the water flow but twice yearly it is recommended to take out the filter element and with a strong jet of water wash from the outside inward. One can do this with a garden hose or high pressure cleaner.

● To take out the filter, remove the storage pipe connection and raise up the upper section of pipe-work by about 10 cm and then lift out the filter casing from the lower pipe. The filter element can then be taken out and cleaned.

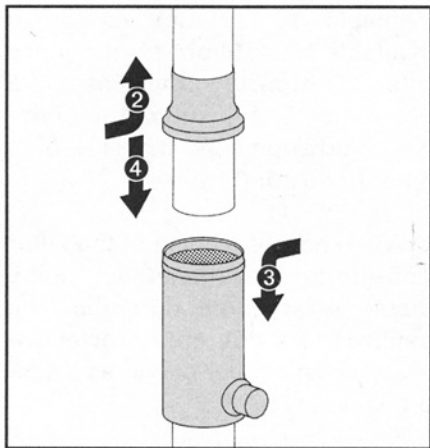

● When correctly installed the upper downpipe ideally penetrates 3cm into the filter cap and the lower downpipe penetrates 3cm up into the filter body.

● It is important to match the filter size with the correct pipe diameter. The top cap of the filter is designed to be a close fit on the pipe to ensure that water flow is directed over the surface of the filter element.

● If the filter element is removed, the unit works as a simple collector without filtering and with very much higher water collecting performance.

② Slide the casing cap onto the upper section of downpipe.

③ Locate the filter casing into the lower section of downpipe.

④ Slide down the casing cap onto the filter casing to lock the filter in position.

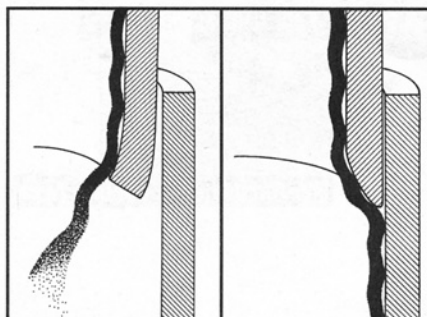

wrong

right